

# Serie 1450

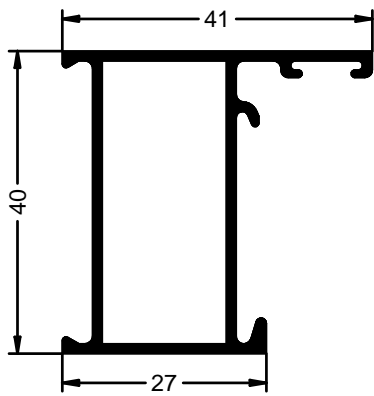

CERCO VENTANA

Ref.-1450

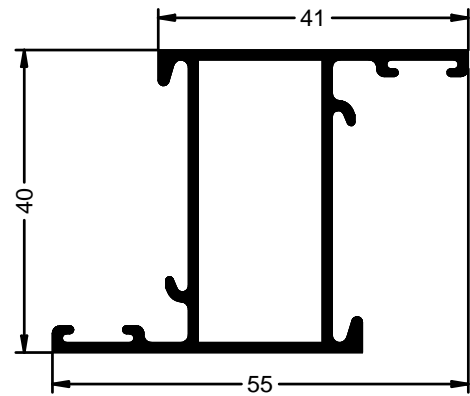

HOJA VENTANA

Ref.-1451

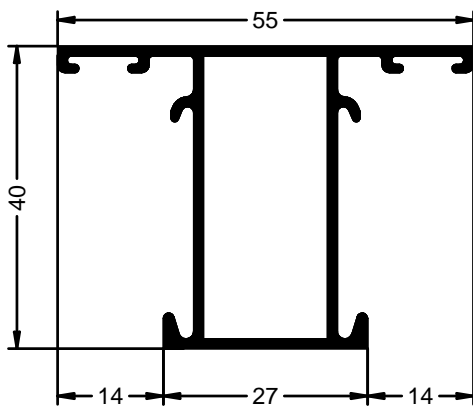

PILASTRA VENTANA

Ref.-1454

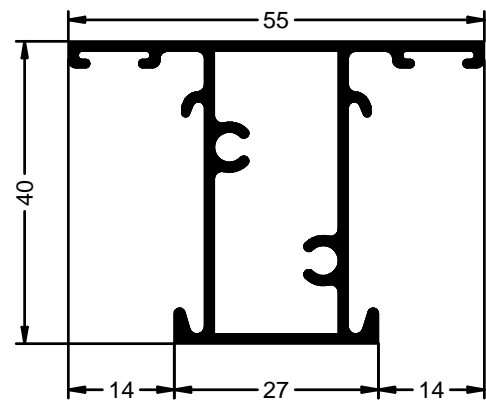

PILASTRA GUSANILO VENTANA

Ref.-1456

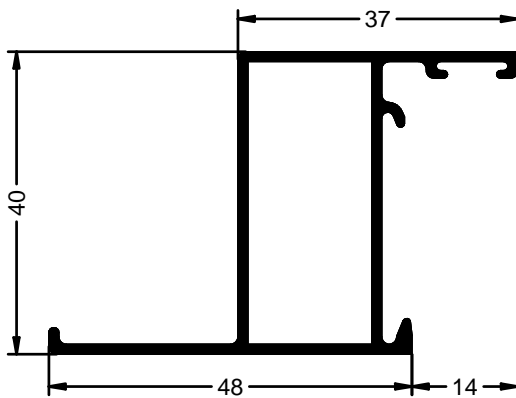

CERCO CON SOLAPE VENTANA

Ref.-1510

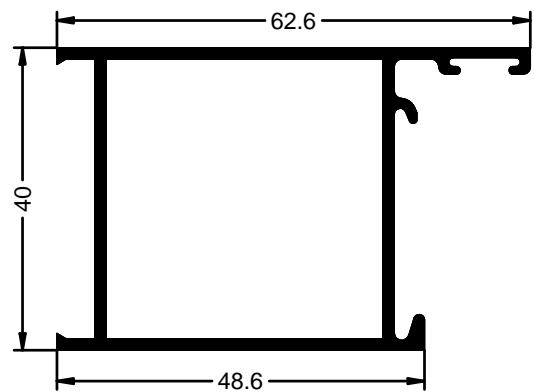

CERCO PUERTA

Ref.-1460

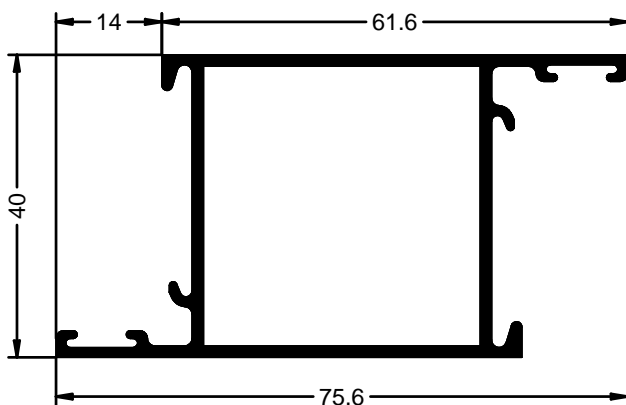

HOJA PUERTA

Ref.-1461

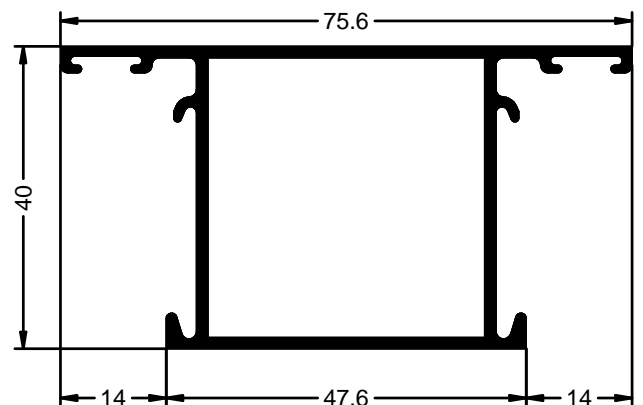

PILASTRA PUERTA

Ref.-1464

# Serie 1450

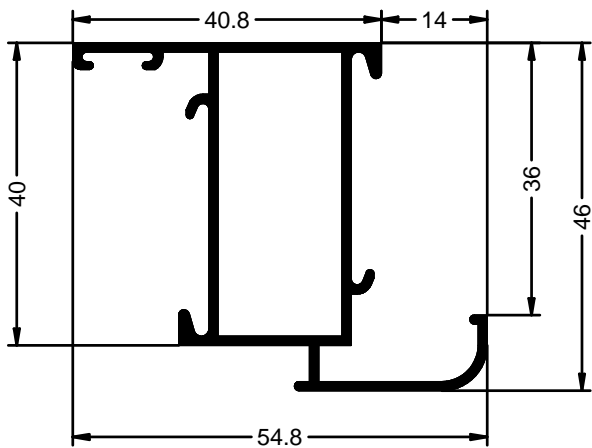

HOJA REDONDA

Ref.-1516

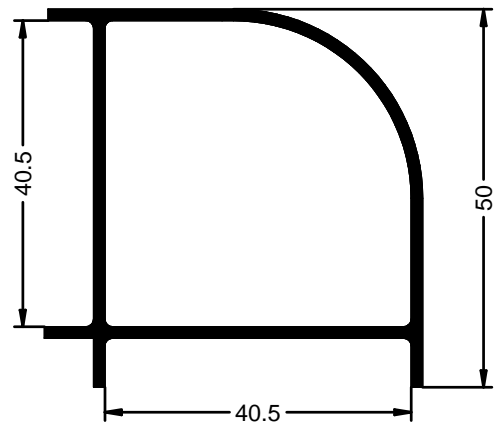

ESQUINERO REDONDO

Ref.-1427

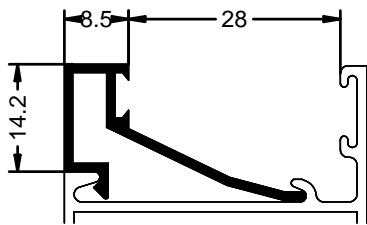

JUNQUILLO

Ref.-1457

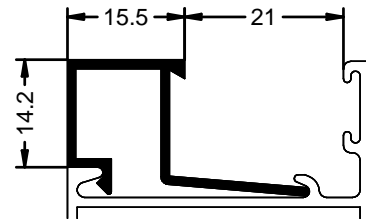

JUNQUILLO

Ref.-1458

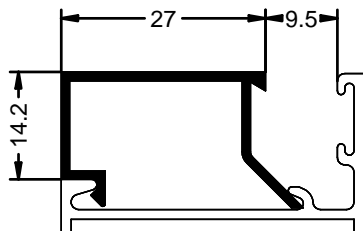

JUNQUILLO

Ref.-1459

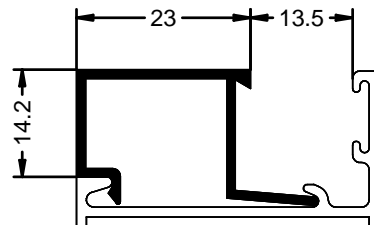

JUNQUILLO

Ref.-1512

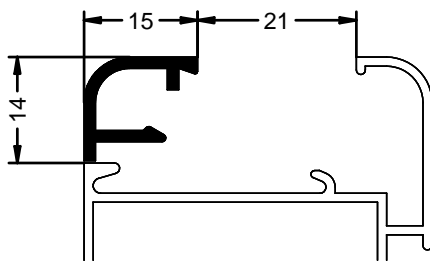

JUNQUILLO

Ref.-1528

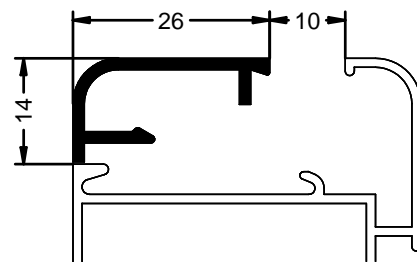

JUNQUILLO

Ref.-1529

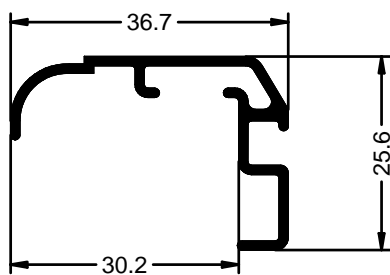

SOLAPE 30 mm.

Ref.-6085

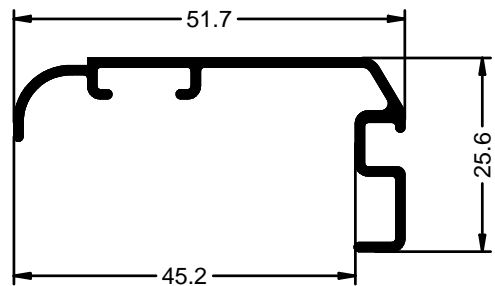

SOLAPE 45 mm.

Ref.-6086

# Serie 1450

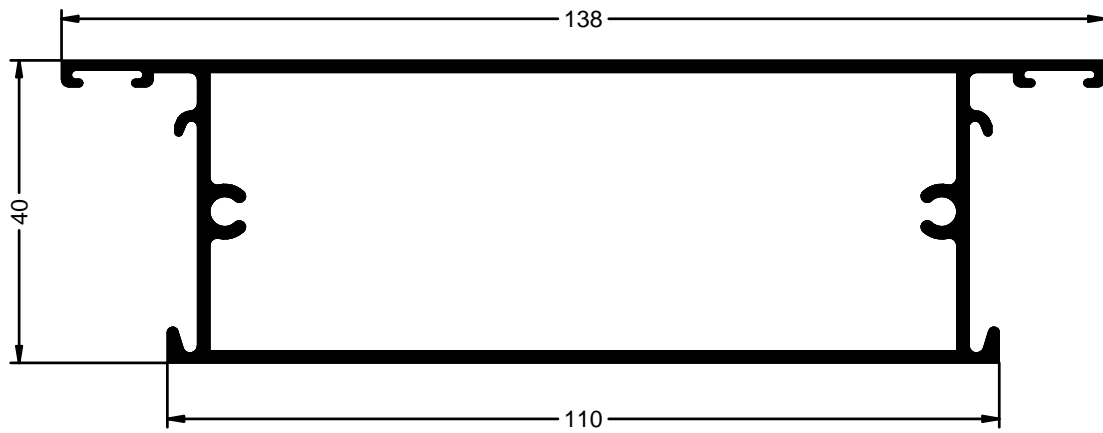

ZOCALO CENTRAL

Ref.-1477

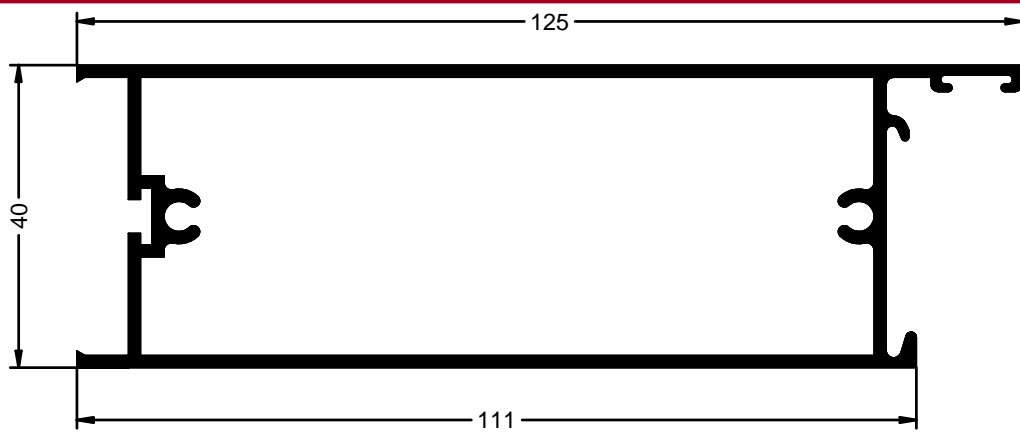

ZOCALO INFERIOR

Ref.-1478

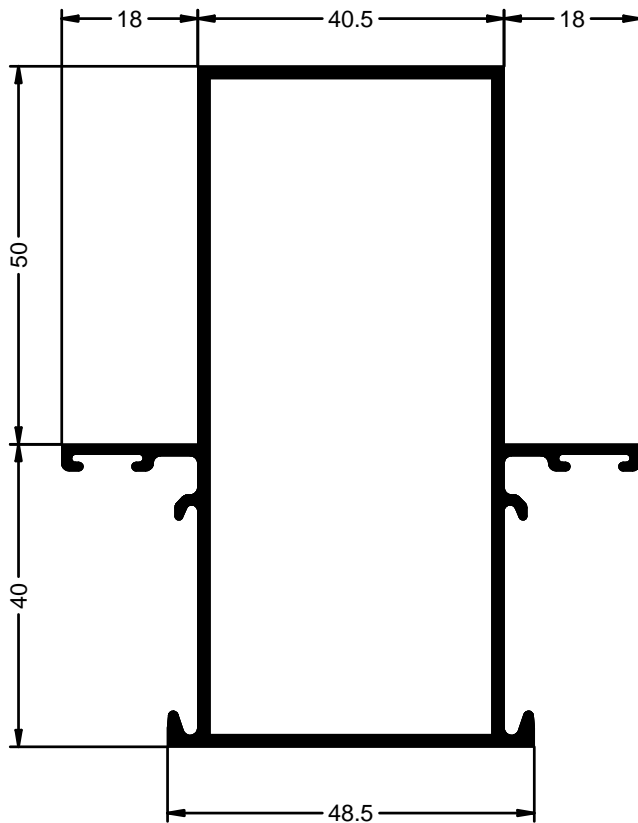

MURO CORTINA

Ref.-1527

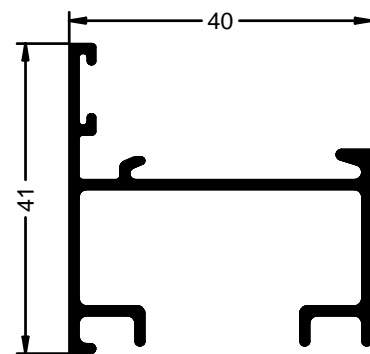

PERFIL PIVOTANTE

Ref.-1447

# Serie 1450

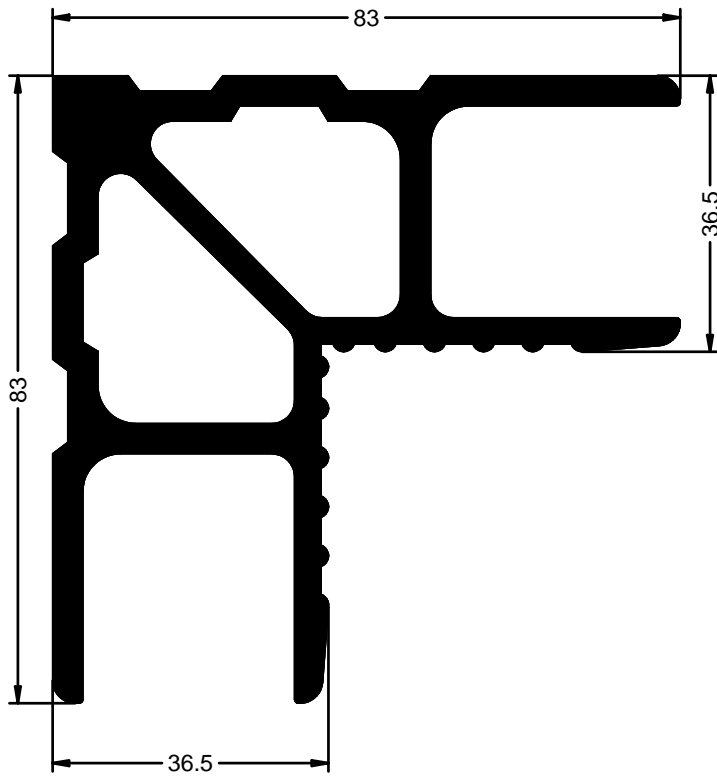

ESCUADRA MAQUINA PUERTA

Ref.-1513

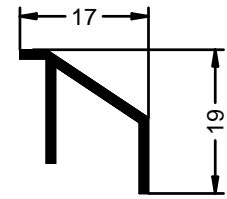

VIERTEAGUAS

Ref.-1416

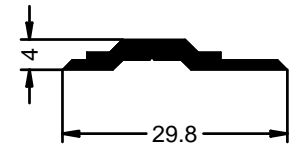

PLETINA CREMONA ANCHA

Ref.-1508

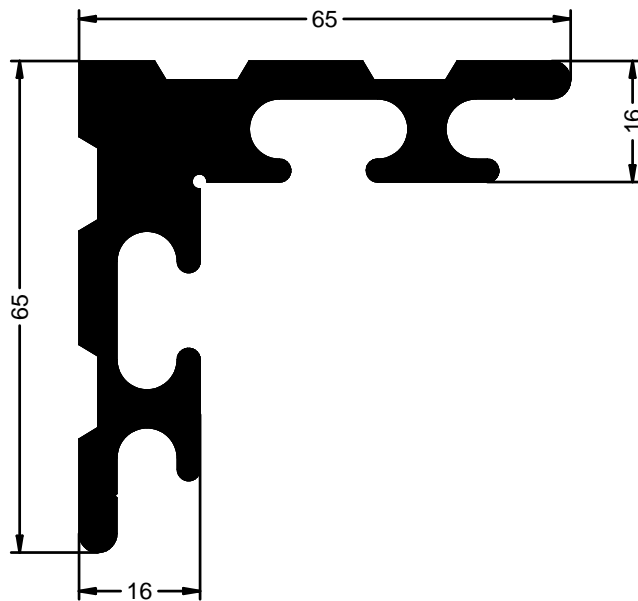

ESCUADRA MAQUINA VENTANA

Ref.-1466

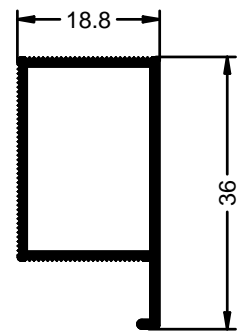

PREMARCO

Ref.-2427

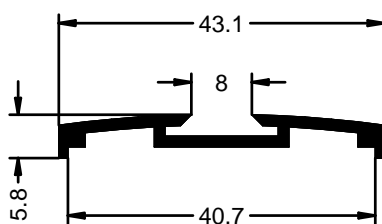

PERFIL VAIVEN

Ref.-1448

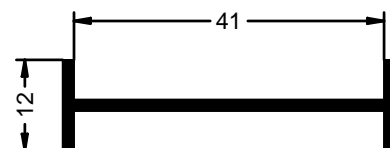

UNION DE CERCOS

Ref.-1471



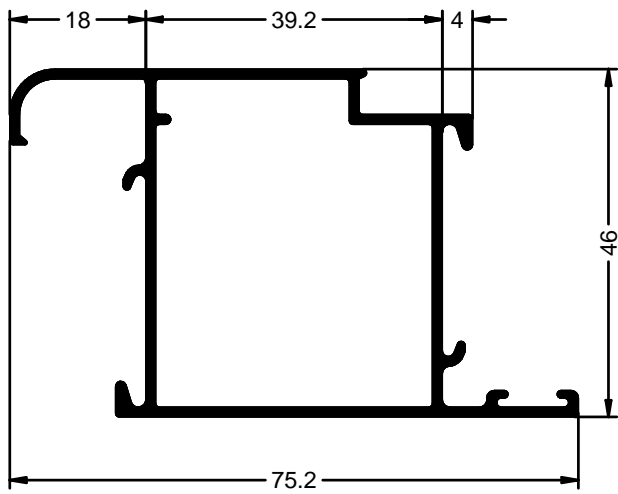













# Serie 1450



HOJA PUERTA ALA CURVA

Ref.-1438







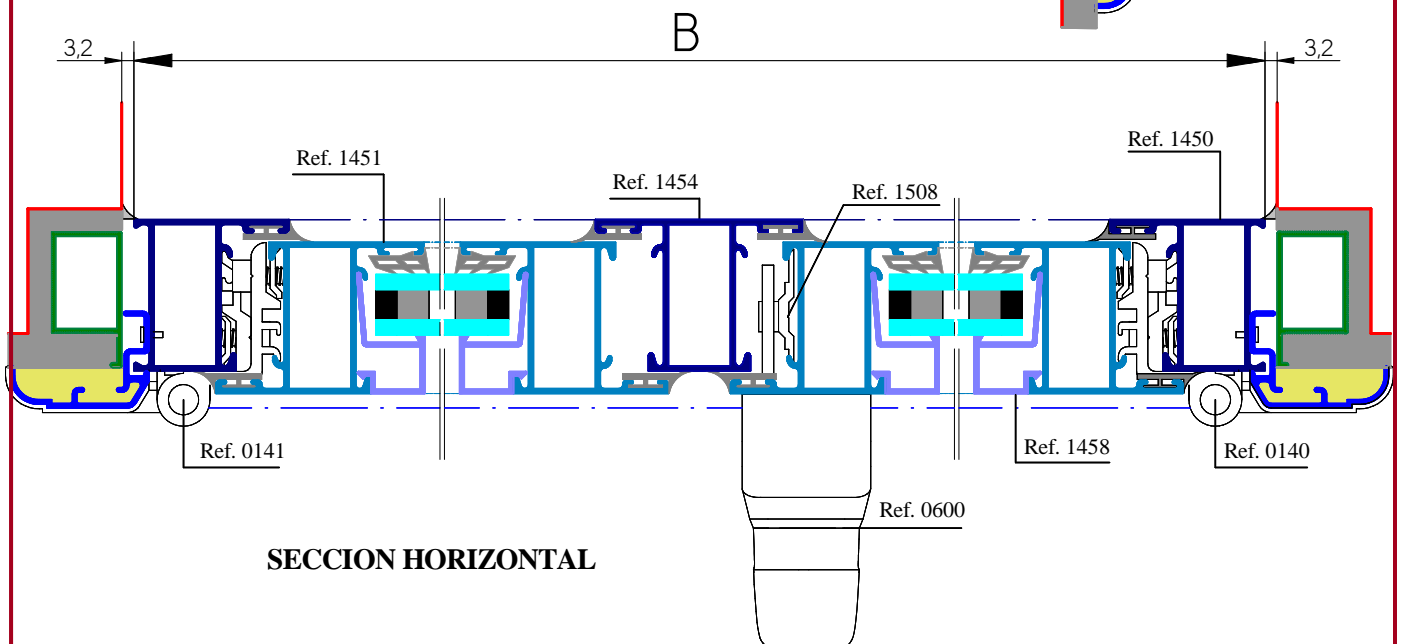
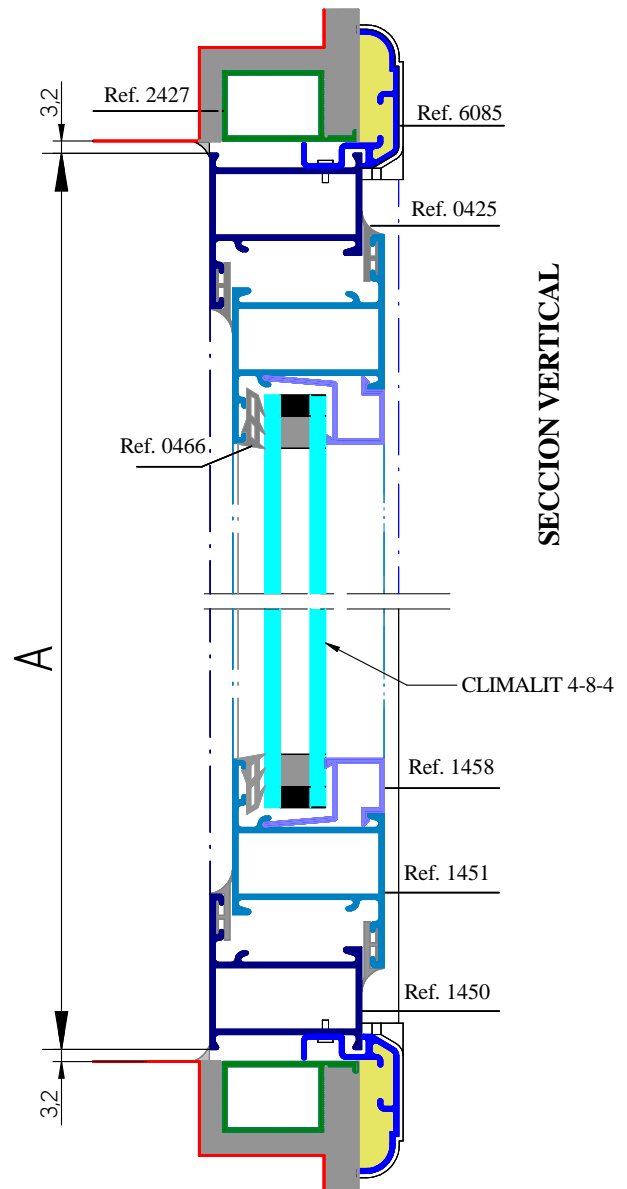







## VENTANA ABATIBLE 2 HOJAS.

CONCEPTO	REF.	CORTE	SIMBOLO	Ud.	MEDIDAS
CERCO VERTICAL	1450	45°		2	=A
CERCO HORIZONTAL				2	=B
HOJA VERTICAL	1451	45°		4	=A-43
HOJA HORIZONTAL				4	=(B-58)/2
PILAstra	1454	90°		1	=A-100
JUNQUILLO VERTICAL	1458	90°		4	=A-154
JUNQUILLO HORIZON.				4	=(B-224)/2
SOLAPE 30 mm. VER.	6085	90°		2	=A-12
SOLAPE 30 mm. HOR.				2	=B-12
PLETINA CREMONA	1508	90°		2	=(B-253)/2
PREMARCO VER.	2427	45°		2	
PREMARCO HOR.				2	
GOMA CERCO VER.	0425	45°		2	=A-58
GOMA CERCO HOR.				2	=B-58
GOMA HOJA VER.	0425	45°		4	=A-28
GOMA HOJA HOR.				4	=(B-30)/2
GOMA PILAstra	0425	90°		2	=A-100
GOMA ACRISTALAR	0466	45°		4	=A-120
				4	=(B-210)/2
CLIMALIT 4-8-4				2	=A-130 =(B-233)/2
KIT 2 HOJA Dchas.	0192			1	
ESCUADRA TORNILLO	0033			12	
ESCUADRA PREMARCO	0143			4	
NUDO SOLAPE 6084	0233			4	

AVISO: Las medidas de este cuadro son orientativas, Cerramientos TorreHierro no se hace responsable de posibles errores que se produzcan al utilizar estas medidas.









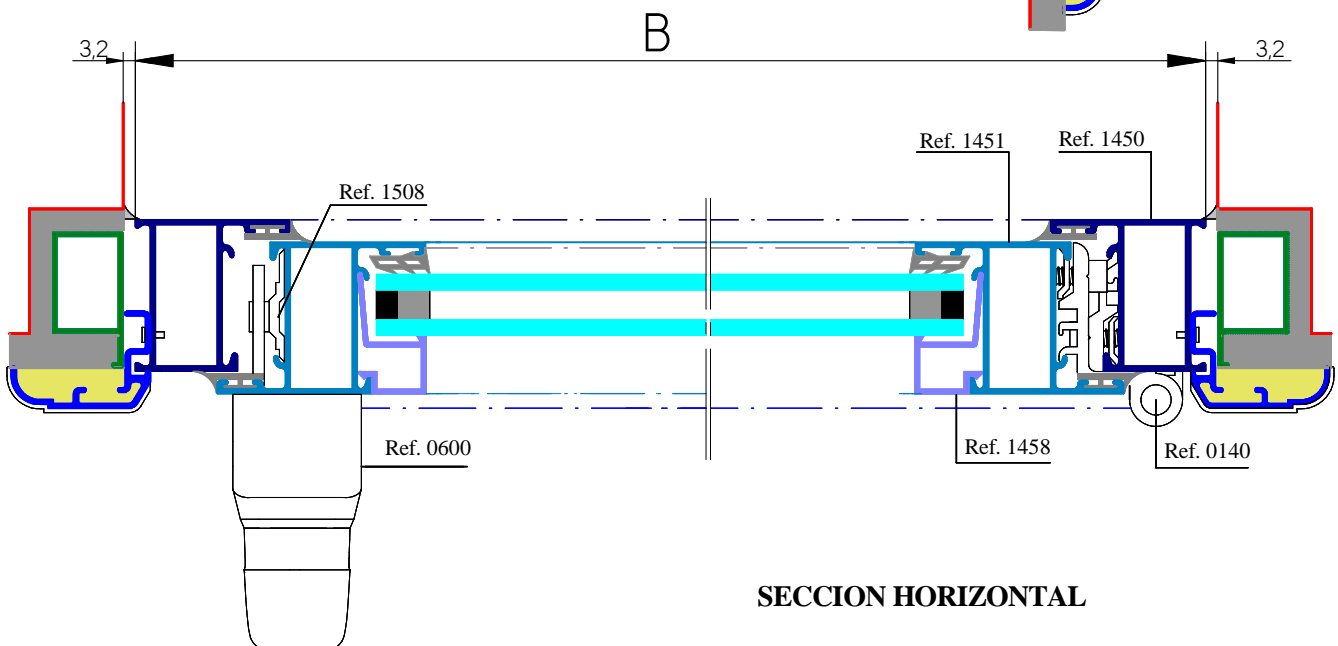
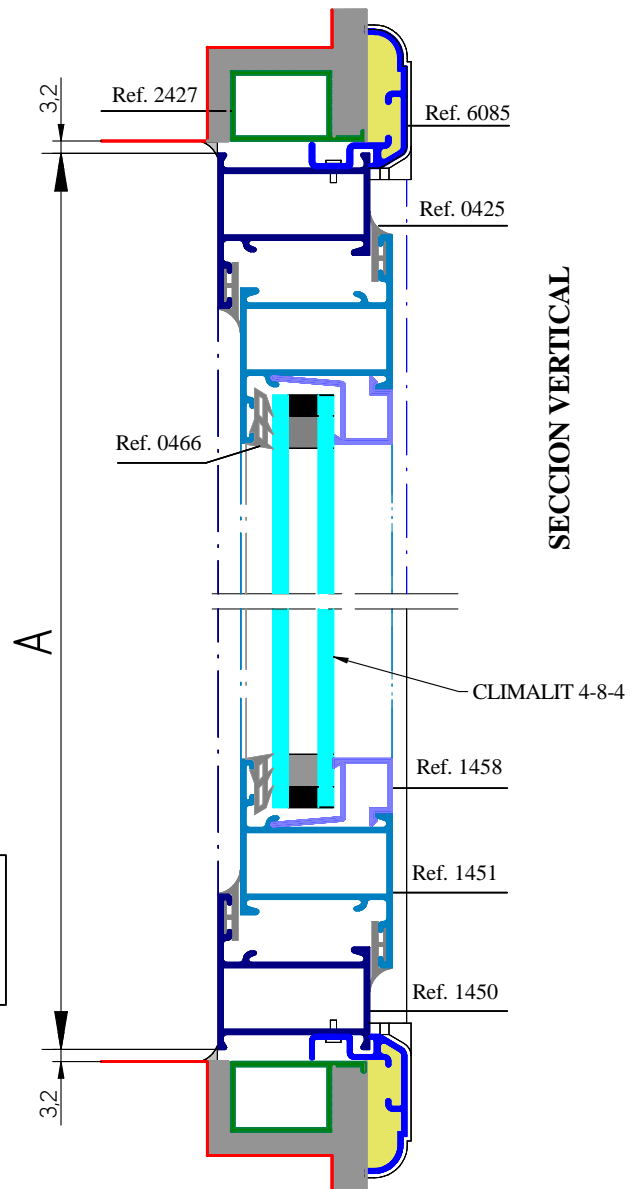







## VENTANA ABATIBLE 1 HOJAS.

CONCEPTO	REF.	CORTE	SIMBOLO	Ud.	MEDIDAS
CERCO VERTICAL	1450	45°		2	=A
CERCO HORIZONTAL				2	=B
HOJA VERTICAL	1451	45°		2	=A-43
HOJA HORIZONTAL				2	=B-43
JUNQUILLO VERTICAL	1458	90°		2	=A-154
JUNQUILLO HORIZON.				2	=B-126
SOLAPE 30 mm. VER.	6085	90°		2	=A-12
SOLAPE 30 mm. HOR.				2	=B-12
PLETINA CREMONA	1508	90°		2	=(B-253)/2
PREMARCO VER.	2427	45°		2	
PREMARCO HOR.				2	
GOMA CERCO VER.	0425	45°		2	=A-58
GOMA CERCO HOR.				2	=B-58
GOMA HOJA VER.	0425	45°		4	=A-28
GOMA HOJA HOR.				4	=A-28
GOMA ACRISTALAR		45°		2	=A-120
CLIMALIT 4-8-4				2	=A-130 =B-130
KIT 2 HOJA Dchas.	0192			1	
ESCUADRA TORNILLO	0033			8	
ESCUADRA PREMARCO	0143			4	
NUDO SOLAPE 6084	0233			4	

**AVISO:** Las medidas de este cuadro son orientativas, Cerramientos TorreHierro no se hace responsable de posibles errores que se produzcan al utilizar estas medidas.



## VENTANA PIVOTANTE





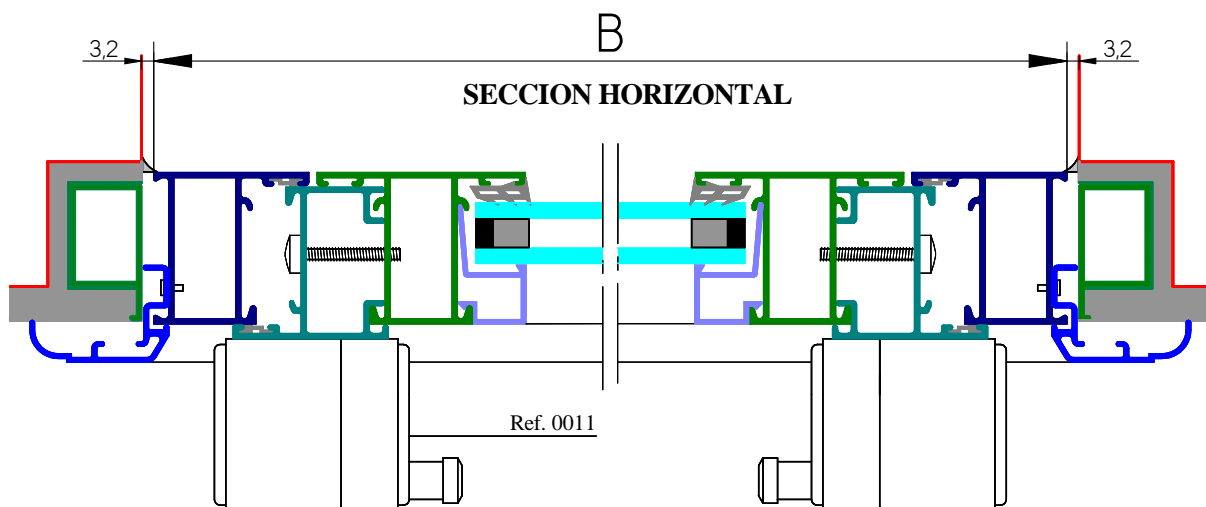
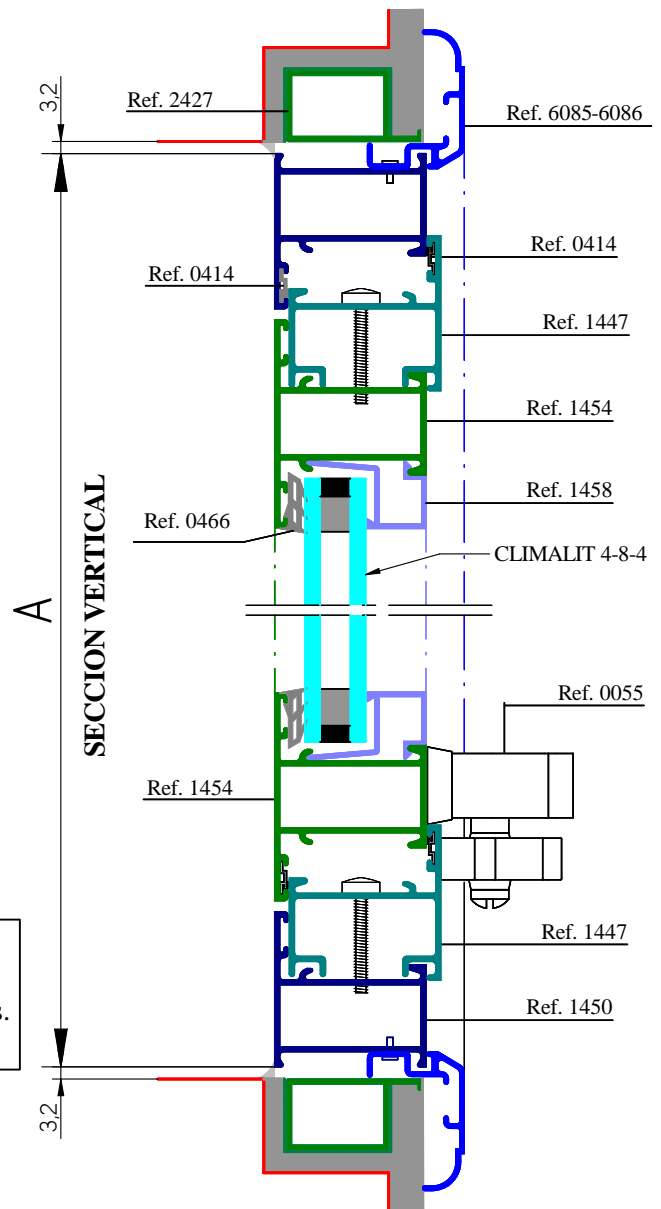





CONCEPTO	REF.	CORTE	SIMBOLO	Ud.	MEDIDAS
CERCO VERTICAL	1450	45°		2	=A
CERCO HORIZONTAL				2	=B
PILAstra VERTICAL	1454	45°		2	=A-88
PILAstra HORIZONTAL				2	=B-88
PERFIL PIVOTANTE VER.	1447	45°/90°		4	=A-42)/2
PERFIL PIVOTANTE HOR.				2	=B-42
JUNQUILLO VERTICAL	1458	90°		2	=A-198
JUNQUILLO HORIZON.				2	=B-170
SOLAPE VERTICAL	6085	45°		2	=A+52
SOLAPE HORIZONTAL				2	=B+52
PREMARCO VERTICAL	2427	90°		2	
PREMARCO HORIZON.				2	
GOMA CERCO VER.	0414	45°		2	=A-61
GOMA CERCO HOR.				2	=B-61
GOMA PER. PIVO. VER.	0414	45°		2	=A-45
GOMA PER. PIVO. HOR.				2	=B-45
CLIMALIT 4-8-4				1	=A-174
					=B-174
CONJUNTO PERNIOS PIVOTANTE	0011			1	
CIERRE DE PRESION	0055			1	
ESCUADRA TORNILLO	0033			8	
ESCUADRA PREMARCO	0143			4	
NUDO SOLAPE 6084	0233			4	

AVISO: Las medidas de este cuadro son orientativas, Cerramientos TorreHierro no se hace responsable de posibles errores que se produzcan al utilizar estas medidas.





## PUERTA ABATIBLE 1 HOJA.

CONCEPTO	REF.	CORTE	SIMBOLO	Ud.	MEDIDAS
CERCO VERTICAL	1460	45-90°		2	=A+Patillas
CERCO HORIZONTAL		45°		1	=B
HOJA VERTICAL	1461	45-90°		2	=A-48
HOJA HORIZONTAL		45°		1	=B-87
ZOCALO CENTRAL	1477	90°		1	=B-202
ZOCALO INFERIOR	1478	90°		1	=B-202
JUNQUILLO VERTICAL	1458	90°		4	=(A-387)/2
JUNQUILLO HORIZON.		90°		4	=B-210
GOMA CERCO VER.	0425	45-90°		2	=A-50
GOMA CERCO HOR.		45°		1	=B-100
GOMA HOJA VER.	0425	45-90°		2	=A-36
GOMA HOJA HOR.		45°		1	=B-72
CLIMALIT 4-8-4				2	=(A-340)/2 =B-215
PERNIO Dchas.				3	
ESCUADRA TORNILLO	0114			6	
POMO	0526			1	

AVISO: Las medidas de este cuadro son orientativas, Cerramientos TorreHierro no se hace responsable de posibles errores que se produzcan al utilizar estas medidas.

